

**PP-7600X  
POS Printer  
User Manual**

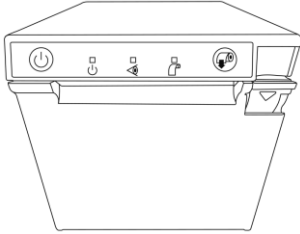

**Package Contents**

- ✓ PP-7600X Thermal Printer.....(x1)
- ✓ 80mm-wide Thermal Paper.....(x1)  
(For operational testing)
- ✓ 58mm Paper Spacer Plate.....(x1)
- ✓ 24V/60W Power Adapter.....(x1)
- ✓ Power Cord.....(x1)
- ✓ USB Cable.....(x1)
- ✓ RS232 Cable (Optional).....(x1)
- ✓ Soft Wiping Cloth.....(x1)  
(For shinning case only)
- ✓ User Manual.....(x1)

**Product Features**

- 3" thermal printer with auto cutter
- Printing speed up to 200 mm/sec
- 80 mm or 58 mm paper width support
- Drop-and-load action for easy paper roll replacement
- Control over 2 cash drawers through 1 D.K port
- Interface: USB (True USB & Virtual COM selectable), Serial and Ethernet
- Paper near end sensor
- Optional LD-2100 light bar modular



**To avoid paper jam occurring, do NOT press the printer's cover open lever or pull the printed paper during printing.**



**When a paper jam occurs, press the cover open lever to release the paper cover. Then, remove the jammed paper and reinstall the paper roll. Next, close the paper cover properly and firmly.**

**If the auto cutter is still jammed, the paper cover will be locked. Should the cutter jam be so serious to interfere the paper cover release operation, please push the paper cover back and press the cover open lever several times. If the problem cannot be solved none the less, please call your local service center for help right away.**

19302901040 Ver. C0

<http://www.posiflex.com>

# **SOME IMPORTANT NOTES**

## **FCC NOTES**

This system meets industry & government requirements and applicable standards. This equipment generates, uses, and can radiate radio frequency energy and, if not installed and used in accordance with the instructions manual, may cause interference to radio communications. It has been tested and found to comply with limits for a Class A digital device pursuant to subpart B of Part 15 of FCC Rules, which are designed to provide reasonable protection against interference when operated in a commercial environment. Operation of this equipment in a residential area is likely to cause interference in which case the user at his own expense will be required to take whatever measures to correct the interference.

This device complies with part 15 of the FCC Rules. Operation is subject to the following two conditions: (1) This device may not cause harmful interference, and (2) this device must accept any interference received, including interference that may cause undesired operation.

## **CE CLASS A WARNING**

This equipment is compliant with Class A of CISPR 32. In a residential environment this equipment may cause radio interference.

## **WARRANTY LIMITS**

Warranty will terminate automatically when the machine is opened by any person other than the authorized technicians. The user should consult his/her dealer for the problem happening. Warranty voids if the user does not follow the instructions in application of this merchandise. The manufacturer is by no means responsible for any damage or hazard caused by improper application.

## **警告使用者**

這是甲類的資訊產品，在居住的環境中使用時，可能會造成射頻干擾，在這種情況下，使用者會被要求採取某些適當的對策。

## **SAFETY INSTRUCTIONS**

This equipment is not suitable for use in locations where children are likely to be present

# Views of the PP-7600X

## Front View

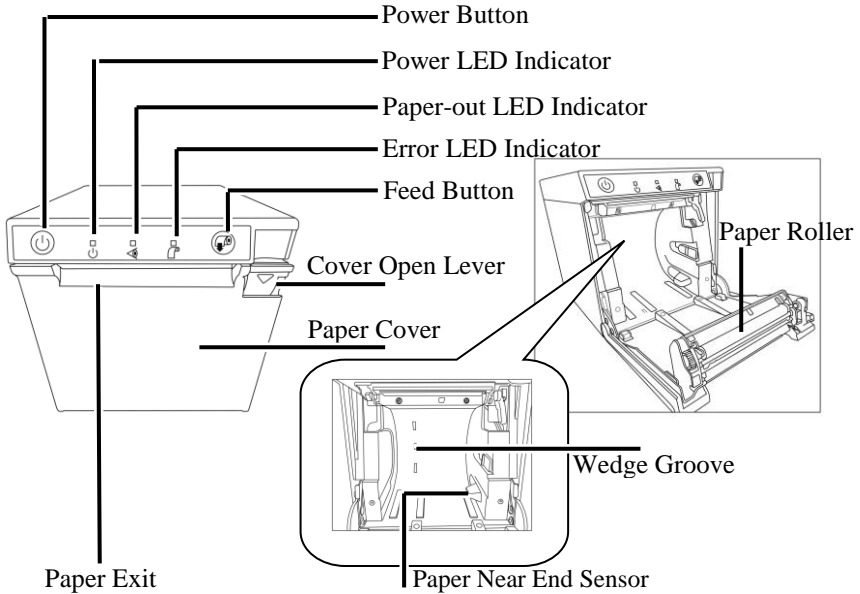

| Part Names              | Description  |
|-------------------------|--|
| Power Button            | This button turns the printer power on or off.   |
| Power LED Indicator     | This indicator turns on when the printer power is on.  |
| Paper-out LED Indicator | This indicator turns on when the paper-out issue occurs.   |
| Error LED Indicator     | This indicator works when the printer has something wrong. For more details, refer to the Status LED Indicators section given below. |
| Feed Button             | Press this button once to feed the paper roll for one line. Hold down this button to continue feeding the roll paper                 |
| Cover Open Lever        | Push this lever to open the paper roll cover.  |
| Paper Cover             | Open this cover when installing or replacing the paper roll.   |
| Paper Exit              | An opening where the paper is outputted  |

| Part Names            | Description  |
|-----------------------|--|
| Wedge Groove          | Aligns and fixes the paper spacer plate  |
| Paper Near End Sensor | (Provided for adjusting the detection position to suit the diameter of the paper core used, and for adjusting the detection position of remaining amount of paper) |

### Rear View

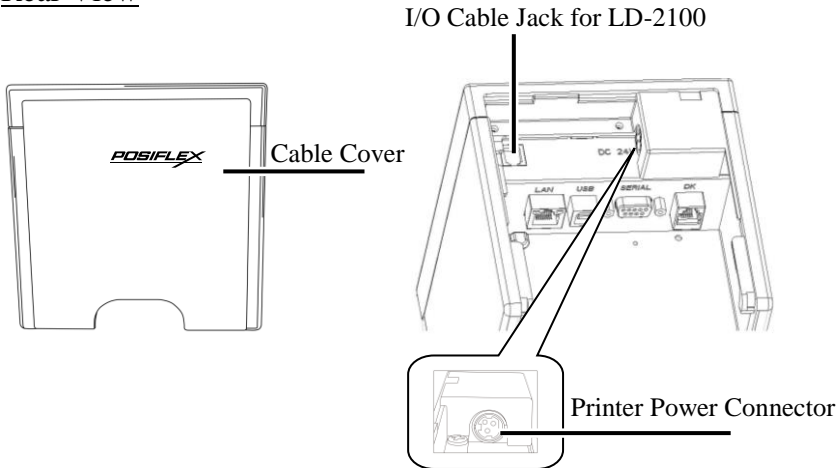

| Part Names                 | Description   |
|----------------------------|---|
| I/O Cable Jack for LD-2100 | Connects the I/O cable of LD-2100                       |
| Printer Power Connector    | Connects the DC cable for the power adapter of PP-7600X |

## Bottom View

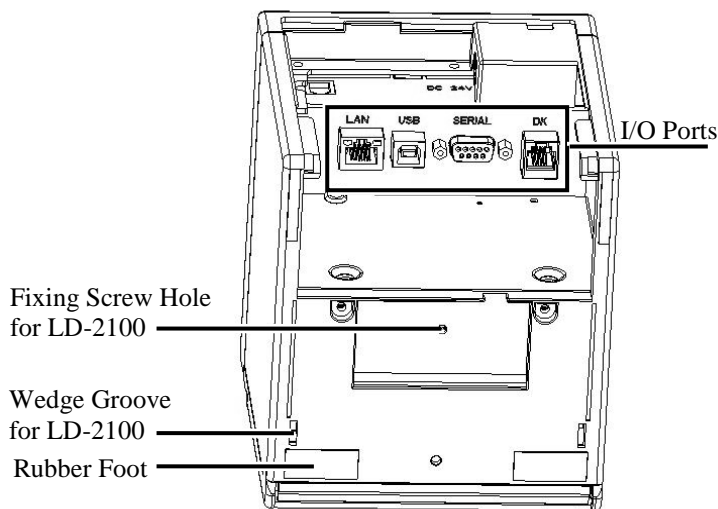

| Part Names                    | Description   |
|-------------------------------|---|
| I/O Ports                     | LAN port connector (RJ45)<br>USB connector (Type-B)<br>Serial port connector (DB9)<br>DK (Drawer Kick) connector (RJ10) |
| Fixing Screw Hole for LD-2100 | Formed for fixing the optional LD-2100 light bar  |
| Wedge Groove for LD-2100      | Formed for fixing the optional LD-2100 light bar  |

## Loading a Paper Roll

Before loading a paper roll, make sure you use a specified paper type. Follow the steps below to load a paper roll.

1. Press down the cover open lever to release the paper cover.

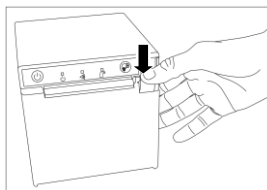

2. The paper cover ejects. Then, open the paper cover manually.

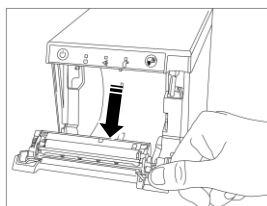

3. Drop the thermal paper inside the paper compartment of the printer, as shown in the right figure.

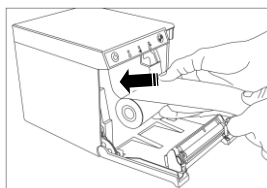

4. Drag the paper roll to the portion where the paper roller is installed.

*Paper Roller*

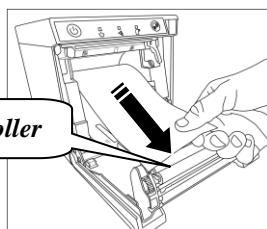

If you want to use a paper roll of 58mm width, install the spacer plate in the compartment of the printer, as shown in the right figure, and then load the paper roll of 58mm width into the partition at the right side of the plate.

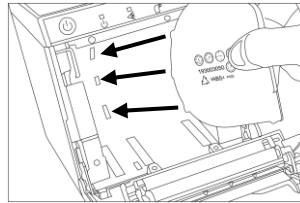

Next, set the paper width by using the PP-7600X software switch utility. The software switch utility can be downloaded from the Posiflex' global website:

<http://www.posiflex.com/en-global/Download/download>. To get more detailed information on the paper width jumper setting, contact directly the Posiflex' technical service team.

5. To avoid the paper cover not being locked completely, push the central portion of the paper cover to close.

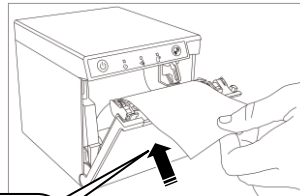

**Push**

## Connecting Power Adapter and I/O Cables

Follow the steps listed below to open the rear cover and connect cables.

1. Hold the concave portion of the cable cover with thumb, as shown in the circled portion of the figure.

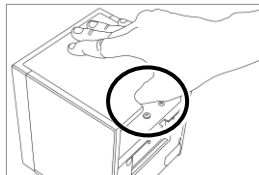

2. Pull the cover in the direction indicated by the arrow in the right figure.

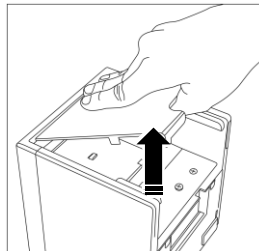

3. Remove the cable cover.

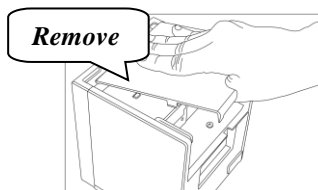

4. Connect power adapter to the printer power connector of the PP-7600X.

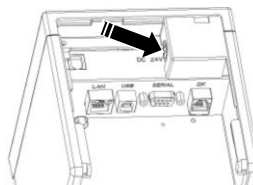

5. Connect I/O cable(s) to the I/O port(s) of the PP-7600X.

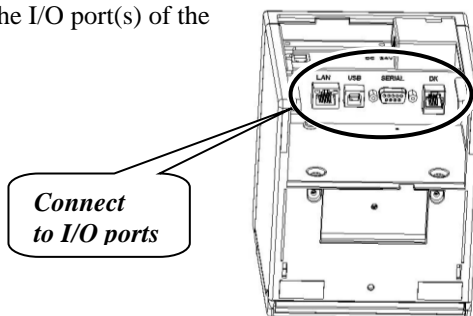





Please follow the instruction given below to connect I/O cables before powering on the printer.

Connect the POS printer with either a USB cable or a RS-232 cable to your POS terminal or with an Ethernet (LAN) cable to your networking device. After being powered ON, the POS printer will automatically detect its connected I/O port.

Reboot the printer if you change the interface cable of the printer.

To set up the Ethernet (LAN) port of the printer, connect the POS printer with a USB cable to your POS terminal and then set up the Ethernet (LAN) port of the printer by using the **Posiflex LAN Wi-Fi Printer Manager**. When completing in setting up the Ethernet (LAN) port, pull the USB cable out of the USB port of the printer and reboot the printer.

6. Make the cable cover wedge to the printer.  
Determine that the cable cover is well wedged to the printer.



7. Cover the I/O ports of the printer.

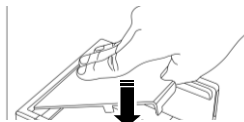

8. Determine that the cable cover is completely closed.

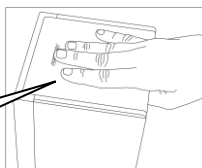

*Firmly Closed*

**CAUTION:** On doing insertion or extraction of a cable connector, please always hold the connector head itself instead of pulling the cable wire. Doing this could damage the cables and ports, which is considered as an artificial damage and is not covered by the warranty. The means of power cord should be connected to a socket-outlet with earthing connection.

**ATTENTION:** Lors de l'insertion ou de l'extraction d'un connecteur de câble, veuillez toujours tenir la tête du connecteur elle-même au lieu de tirer le fil du câble. Cela pourrait endommager les câbles, ce qui est considéré comme un dommage artificiel et n'est pas couvert par la garantie. Le cordon d'alimentation doit être connecté à une prise de courant avec mise à la terre.

## Setting up the Printer

The PP-7600X can be set through the specific software switch setting utility for setup of other functions. Please visit our web site <http://www.posiflex.com/en-global/Download/download> to download the **PP-7600X Thermal Printer Software Switch Utility for Windows**. Software switches are divided into **SW1, SW2, SW3, and SW4**. After downloading the utility, please call your service center for support before operating the software switch setup.

**Please reboot the printer after the switch settings are done.**

## Installing the Posiflex LAN POS Printer Manager

To allow you to easily do settings of the LAN printer, please install the LAN POS printer Manager Utility (Utility Name: *PP-7600 Series LAN and WIFI POS printer Manager Utility*). To download the manager, go to the Posiflex' global website: <http://www.posiflex.com/en-global/Download/download> to download the up-to-date utility.

After downloading the manager utility, it is suggested to do settings through USB interface.

However, to avoid users doing settings by mistake, it is suggested that professional technicians implement the setup. To do more advanced settings on the printer, contact directly the Posiflex' technical service team.

## Installing the USB Printer Virtual COM Port Driver

If you use software programs that communicate with your POS terminal via a serial interface (e.g. COM1...COM8), but your POS system does not have any serial port, you will require a so-called virtual COM port driver. This virtual COM port driver allows you to assign a virtual COM port connection number to your POS terminal connected via a USB port and enables bidirectional communication between your POS terminal and the printer.

To download the USB Printer Virtual COM Port Driver, go to the Posiflex' global website: <http://www.posiflex.com/en-global/Download/download> to download the up-to-date driver of the PP-7600X printer.

After downloading the driver, start to install it. When you finish installing the driver, it is suggested to turn on your POS terminal again. The system will automatically detect the PP-7600X printer.

## Installing the LD-2100 Light Bar (Optional)

Follow the steps below to install the LD-2100 light bar on the PP-7600X printer.



Power off the printer when installing the LD-2100 light bar.

1. Securely connect the pin header of the LD-2100 I/O cable to the pin connector on the LD-2100 control board.

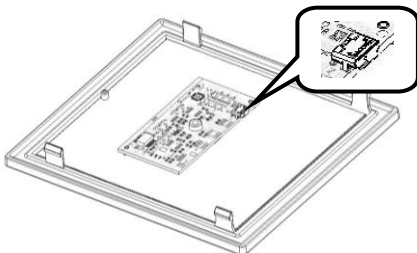

2. Plug the RJ11 connector of the LD-2100 cable into the LD-2100 I/O cable jack of the PP-7600X printer.

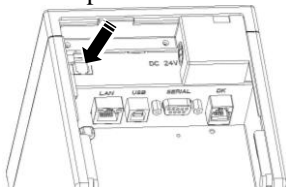

3. Install the LD-2100 light bar onto the bottom side of the PP-7600X by making the four joints formed on the LD-2100 wedge to the four wedge grooves formed on the PP-7600X.

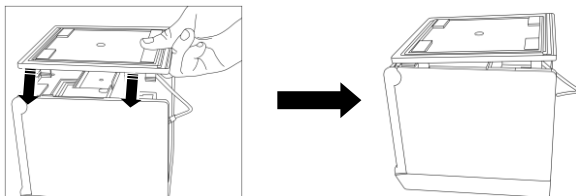

4. Determine that the LD-2100 securely connects to the PP-7600X.



5. Fix the LD-2100 to the bottom side of PP-7600X with a screw.

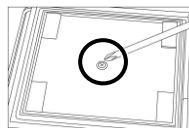

6. The installation of LD-2100 light bar is completed.

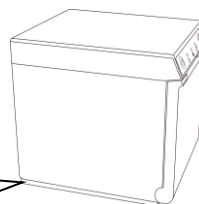

LD-2100  
Light Bar

After installing the LD-2100 light bar, you can set up the LD-2100 by using the Posiflex LD2100 Tool. For more detailed information, refer to the Posiflex LD2100 Tool. To download the LD2100 Tool and its manual, go to the Posiflex' global website: <http://www.posiflex.com/en-global/Download/download>.

### Powering ON the PP-7600X Printer

1. Press the power button of the printer.

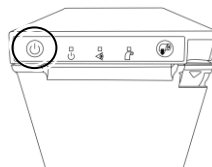

2. The power LED indicator stays bright and solid green when the printer is powered ON.

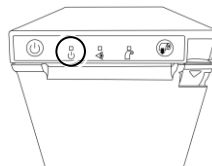







## Status LED Indicators

After supplying power to the PP-7600X and powering ON the printer, you can read the system operation status from the power LED indicator on the printer. The LED status is described below.



| LED           | Status                     | Description          |
|---------------|----------------------------|----------------------|
| Power LED     | Solid green                | System ON            |
| Error LED     | Flash red + several beeps  | Cutter abnormal      |
|               | Solid red                  | Cover open           |
|               | Flash red                  | Operation temp. high |
| Paper-out LED | Solid red + continual beep | Paper out            |

## Performing a Self-Test of the Printer

1. Power off the printer.
2. Press and hold the feed button  of the printer.
3. Power on the printer. The printer will emit one short beep sound.
4. Release the feed button .
5. The printer performs a self-test and prints out the self-test result.  
If the paper-out LED indicator  still turns bright in red, press the feed button  of the printer to make the printer print the remaining self-test result.
6. Release the feed button  of the printer and then the paper-out LED indicator  does not light.



## Entering the Hexadecimal Dump Mode

To make the printer work in the hexadecimal dump mode, please go through the following instructions.

1. Power off the printer.
2. Open the paper roll cover manually.
3. Press and hold the feed button  of the printer.
4. Power on the printer. The printer will emit one short beep sound.
5. Release the feed button .
6. Close the paper roll cover manually.
7. The printer enters the hexadecimal dump mode and prints out the result showing the “*Hexadecimal Dump*” message.



## Doing Software Switch Reset

**Software Switch Reset** is the specially-designed function aimed to facilitate the factory-default reset process. Please go through the following instructions to reset your printer to factory-default settings using **Software Switch Reset**.

1. Power off the printer.
2. Open the paper roll cover manually.
3. Keep pressing the feed button  and then power on the printer. The printer will emit one short beep sound.
4. Press the feed button  of the printer **2** times.
5. Close the paper roll cover manually.
6. The printer will emit one short beep sound and then print a page displaying software switch factory-default settings.
7. The printer will restart by itself.

## Doing LAN Settings Reset

Among multiple built-in functions, **LAN Settings Reset** mainly allows you to reset LAN settings to factory default. The following steps are provided to help you complete the reset process.

1. Power off the printer.
2. Open the paper roll cover manually.
3. Keep pressing the feed button  and then power on the printer. The printer will emit one short beep sound.
4. Press the feed button  of the printer **4** times.
5. Close the paper roll cover manually.
6. The printer will emit one long beep sound and then print a page displaying LAN default settings.
7. The printer will restart by itself.
8. Ensure that LAN settings is correctly set to factory default as follows:

| LAN Interface Information for Factory Default |                   |
|---|-------------------|
| IP Address                                    | 192.168.192.168   |
| MAC Address*                                  | 00.19.17.00.02.03 |
| NETMASK                                       | 255.255.255.0     |
| GATEWAY                                       | 192.168.192.1     |
| LINK STATUS*                                  | DISCONNECT        |
| FIRMWARE VERSION*                             | 1.1.2             |

**Note:** Values of the items marked with an asterisk “\*” are reserved and not allowed to be changed.

## Cleaning

### ➤ Cleaning the Printer Case

Before cleaning the printer case, be sure to power off the printer, and wipe the dirt off the printer case with a soft wiping cloth we provide.



Do NOT clean the product with alcohol, benzene, thinner, or other such solvents. Doing so may damage or break the parts made of plastic and rubber.

### ➤ Cleaning the Thermal Head and the Platen Roller

We recommend cleaning the thermal head to maintain receipt print quality. We also recommend cleaning periodically (about once every 3 months).

Depending on the paper roll used, paper dust may stick to the platen roller and the paper may not be fed correctly. To remove the paper dust, clean the platen roller with a cotton swab moistened with water. Power on the printer only after the water has completely dried.



- ✚ After printing, the thermal head and its surroundings can be very hot. Be careful. Let it be cool before you clean it.
- ✚ Do not damage the thermal head with your fingers or any other hard object.

## Troubleshooting

### ➤ The printer cannot print

If you cannot print even though an error has not occurred, perform a self-test to check if printing is possible.

Follow the steps below.

1. Close the paper cover.
2. While pressing the feed button, power on the printer. (Hold down the feed button until printing starts.) The current print status is printed.
3. Briefly press the feed button (less than one second) to continue the self-test. The printer prints using the built-in character set. After the self-test printing, the printer is reset and switches to standard mode.

### ➤ LED Indicators are On/Flashing/Off

#### No lights is given by the LED indicators

Check whether the power supply cable is correctly connected to the printer and the socket.

### Error LED is on

- ✓ Check whether the paper cover is closed.
- ✓ Check if paper jam occurs or foreign substance enters the paper cutter.
- ✓ The thermal head and its surroundings can be very hot. Printing stops if the thermal head is too hot. Printing starts again automatically when the thermal head temperature falls.

### Paper-out LED indicator is on

- ✓ Check whether the paper roll is correctly installed and any paper roll remains.

### Error LED indicator is flashing

Power off the printer; after 10 seconds, power it back on. If the error LED indicator turns on again even after turning the power back on, malfunction may occur. Contact your dealer or Posiflex' technical service team.

## Specifications

| General                    |  |
|----------------------------|--|
| Printer Reliability        | 100 Km print length  |
| Auto Cutter Reliability    | 700,000 cuts or more   |
| NV Bit Image Memory        | 24KB (max.)  |
| NV Graphics                | 256KB (max.)   |
| Receive Buffer             | 6KB  |
| Printer Driver             | Windows Driver (APD), OPOS, JavaPOS (Win), CUPS Driver (Linux)   |
| Software                   | Posiflex Utility (Android), PP-7600 Utility (Windows Desktop), Development Tool (Android SDK), Monitoring Tool (RMS) |
| LED Indicators             | Green LED - On = Power<br>Red LED - Error and/or Paper Out   |
| Sensors                    | Cover Open / Out-of-Paper /Paper Near End  |
| Cash Drawer Port (CR port) | 2 drivers (CR port x1)   |
| Power Consumption          | Approx. 1.5A (mean)  |
| Power Source               | AC adapter (24V DC)  |
| Power Saving               | Yes  |
| Temperature                | Print quality assured: +5°C ~ +40°C<br>Operating: 0°C ~ +40°C<br>Non-operating: -20°C ~ +60°C                        |



|                         |   |
|-------------------------|---|
| Relative Humidity       | Operating: 20 ~ 85%, non-condensing 35% above for auto cutter<br>Non-operating: 5% ~ 90%, non-condensing (paper excluded) |
| Acoustic Noise Level    | 55db  |
| Standards and Approvals | CE / FCC  |
| Dimensions (W x D x H)  | 5.08" x 5.86" x 5.1" / 129 x 148.8 x 129.5 mm   |
| Weight                  | 2.2lbs / 1kg  |
| Color                   | Black / White   |
| <b>Print</b>            |   |
| Print Method            | Thermal dot line printing   |
| Print Speed             | 200 mm/second (max.)  |
| Print Resolution        | Up to 8 dots/mm and 576 dots/line   |
| Print Direction         | Vertical and Horizontal   |
| <b>Print Fonts</b>      |   |
| Fonts/Column capacity   | Font A: 12 x 24 48 cpl (default); Font B: 8x16 64 cpl for 576 dots  |
| Character Size          | Font A: 1.25 x 3.00 mm; Font B: 1.13 x 3.00 mm  |
| Character Set           | 95 Alphanumeric, 18 International, 128 x 43 Graphic   |
| Barcode                 | UPC-A/E, EAN13/8, ITF, CODE39 / 93 / 128, CODABAR, GS1 DataBar  |
| 2D Symbol Printing      | PDF417, QR code   |
| <b>Media Handling</b>   |   |
| Type                    | Thermal roll paper  |
| Print Width             | 64 mm (512 dots/line, default)/72 mm (576 dots/line) /53 mm (424 dots/line)   |
| Paper Width             | 80 or 58 + 0 / - 1 mm   |
| Roll Diameter (Max)     | 81 mm   |
| Paper Thickness         | 60 ~ 80 um  |
| Paper Guide             | Yes   |
| Auto Cutter             | Yes   |
| Near end Sensor         | Yes   |

| <b>Connectivity</b>     |                          |
|-------------------------|--------------------------|
| Serial Interface        | RS-232                   |
| USB Interface           | Built-in USB             |
| Ethernet Interface      | Ethernet 10/100Base-T/TX |
| <b>Operating System</b> |                          |
| OS support              | Android, Linux, Windows  |

**※ The product information and specifications are subject to change without prior notice. To get the detailed information on PP-7600X, please check this model from Posiflex Global Website (<http://www.posiflex.com/en-global/Download/download>).**

**<MEMO>**

**<MEMO>**